

Sarah Hartmann, Alexander Haffner

# Linked-RDA-Data in der Praxis

# Linked Library Data

- öffentlich zugängliches Netz von strukturierten Informationen
  - ▲
    - ermöglichen von Suchabfragen
- Nachnutzung bereits erschlossener Entitäten
  - Ausbau kooperativer Katalogisierung
  - Vermeidung bzw. Reduzierung redundanter Informationen
- Bereitstellung von Bibliotheksdaten für nicht-bibliothekarische Community
- automatisierte Datenanreicherung von Bibliotheksdaten durch externe Daten

# Resource Description and Access (RDA)

- neuer internationaler Erschließungsstandard
  - zur Erschließung aller Objekttypen
  - Ablösung von AACR2, RAK-WB, RSWK
- community-übergreifender Standard
- Nutzerbedürfnisse stehen im Vordergrund
- basiert auf FRBR und FRAD
- unabhängig von Metadatenformaten
- RDA-Toolkit Veröffentlichung Juni 2010
- Fokus auf Relationen, Rollen, kontrolliertem Vokabular

# RDA-Ontologie

- Definition eines Semantic-Web-konformen RDA-Formats durch die DCMI/RDA Task Group
  - RDA Element Sets (Classes, Properties in RDFS)
    - z. B. „Werk“, „Title“, „Content type“
  - RDA Value Vocabularies (kontrolliertes Vokabular in SKOS)
    - z. B. „spoken word“ (instance of content type)
- <http://metadataregistry.org/rdabrowse.htm>



# RDA-Beispiel



## Werk

rda:prefTitleForTheWork:  
The body in the library  
rda:formOfWork: Roman  
rda:dateOfWork: 1942

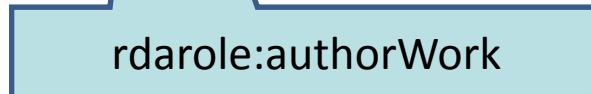
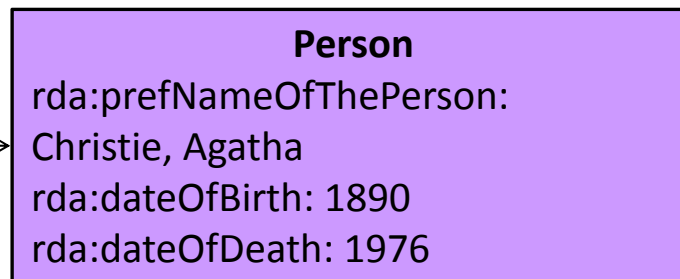
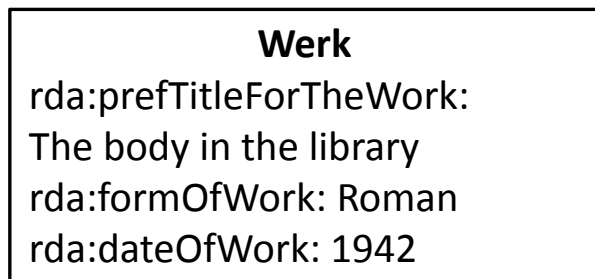

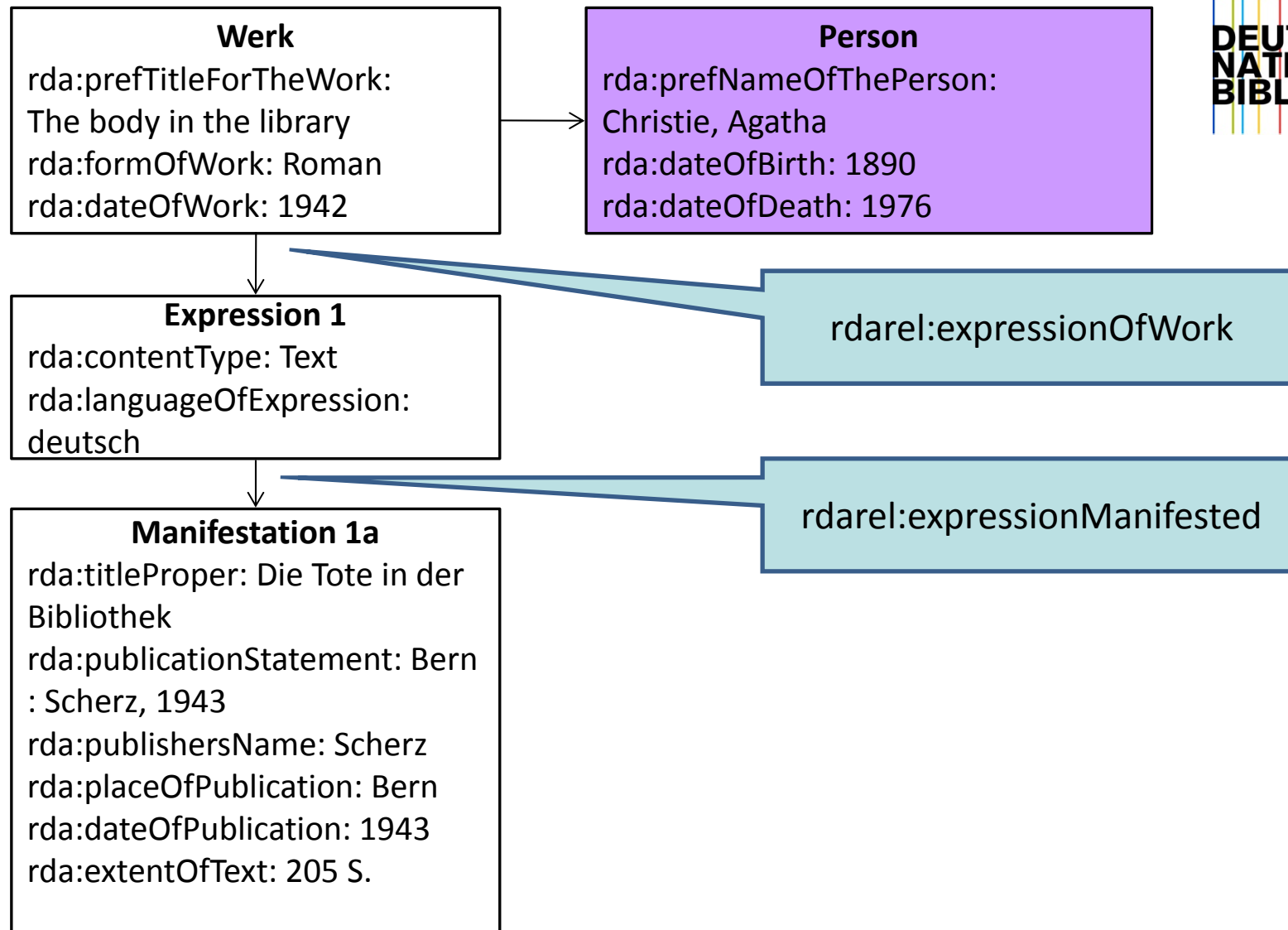

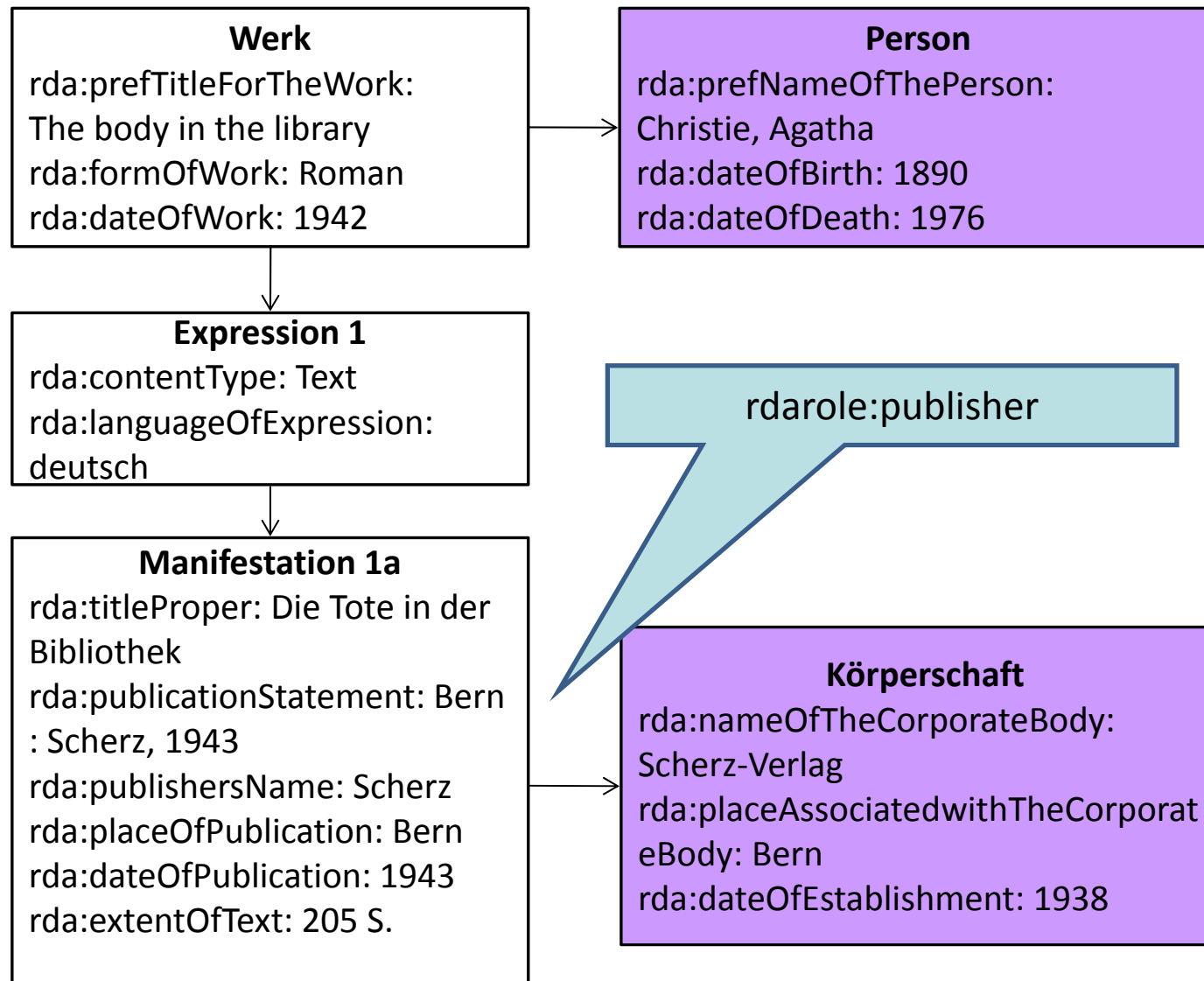



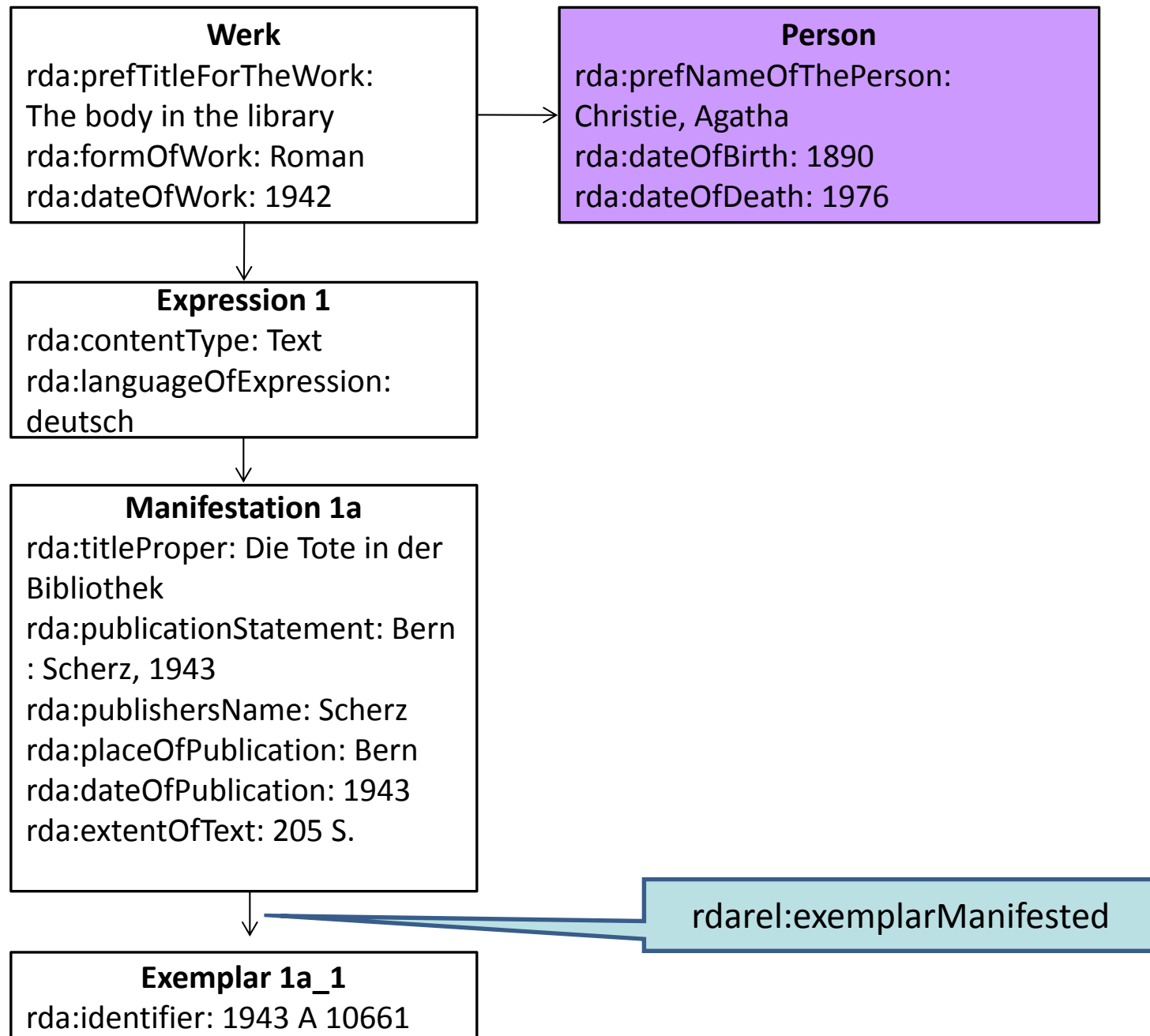

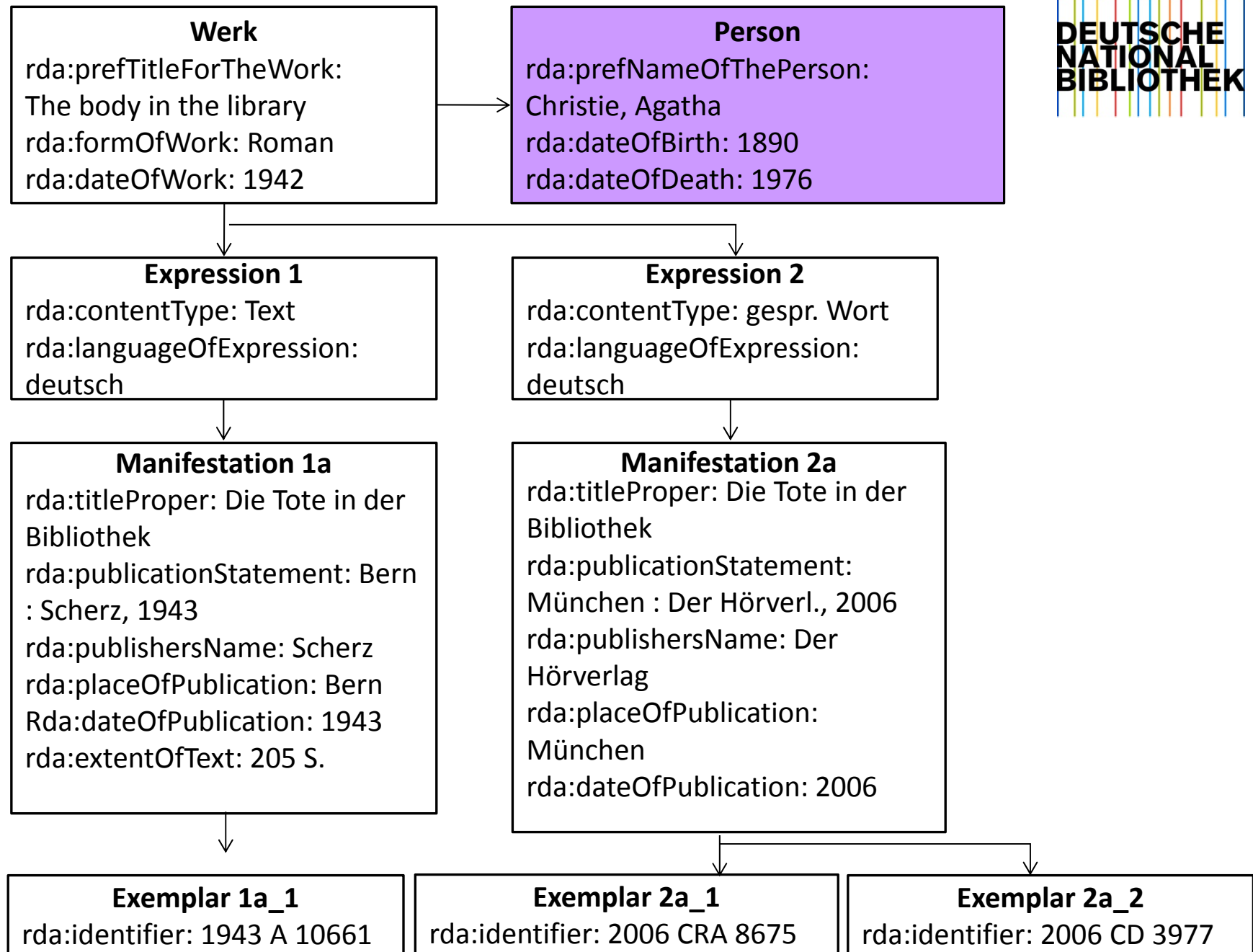

# Linked-RDA-Data-Beispiel

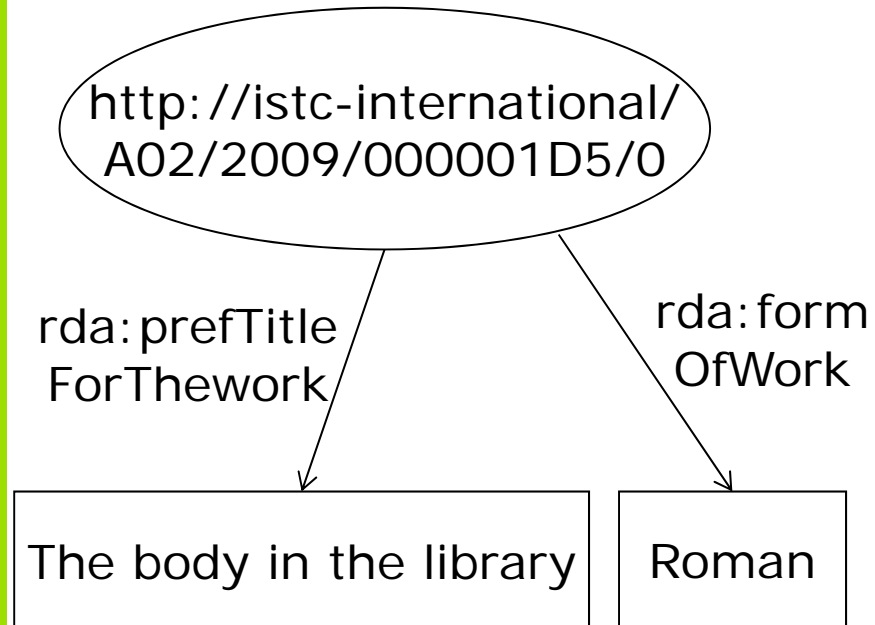

# Linked-RDA-Data-Beispiel

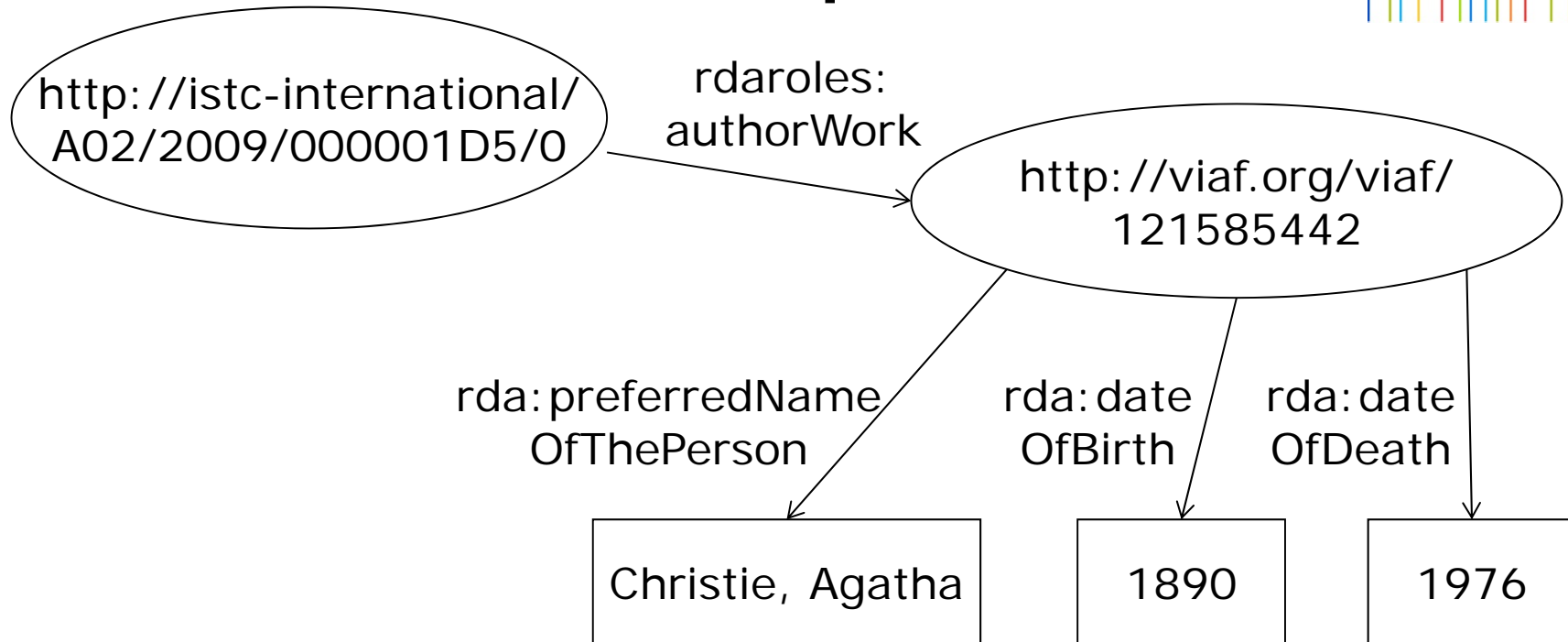

# Linked-RDA-Data-Beispiel

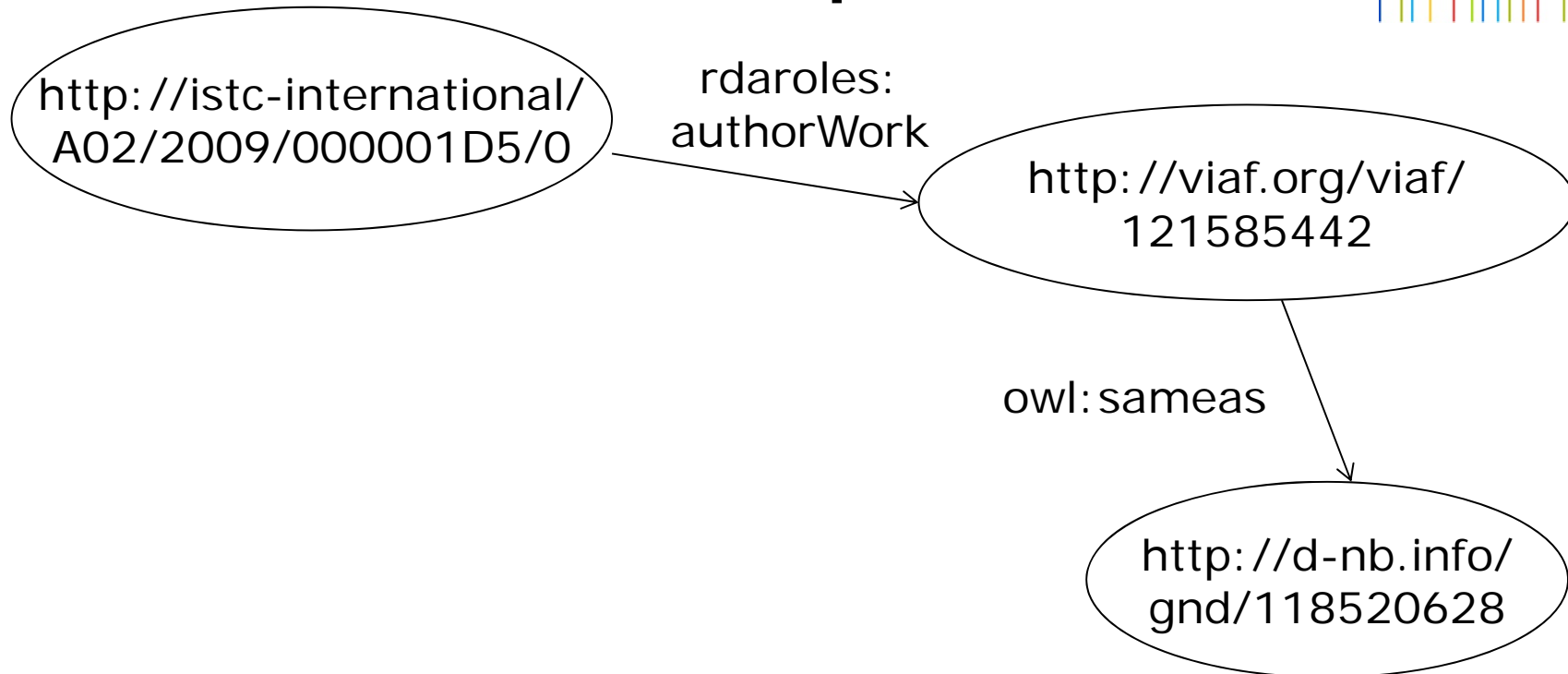

# Linked-RDA-Data-Beispiel

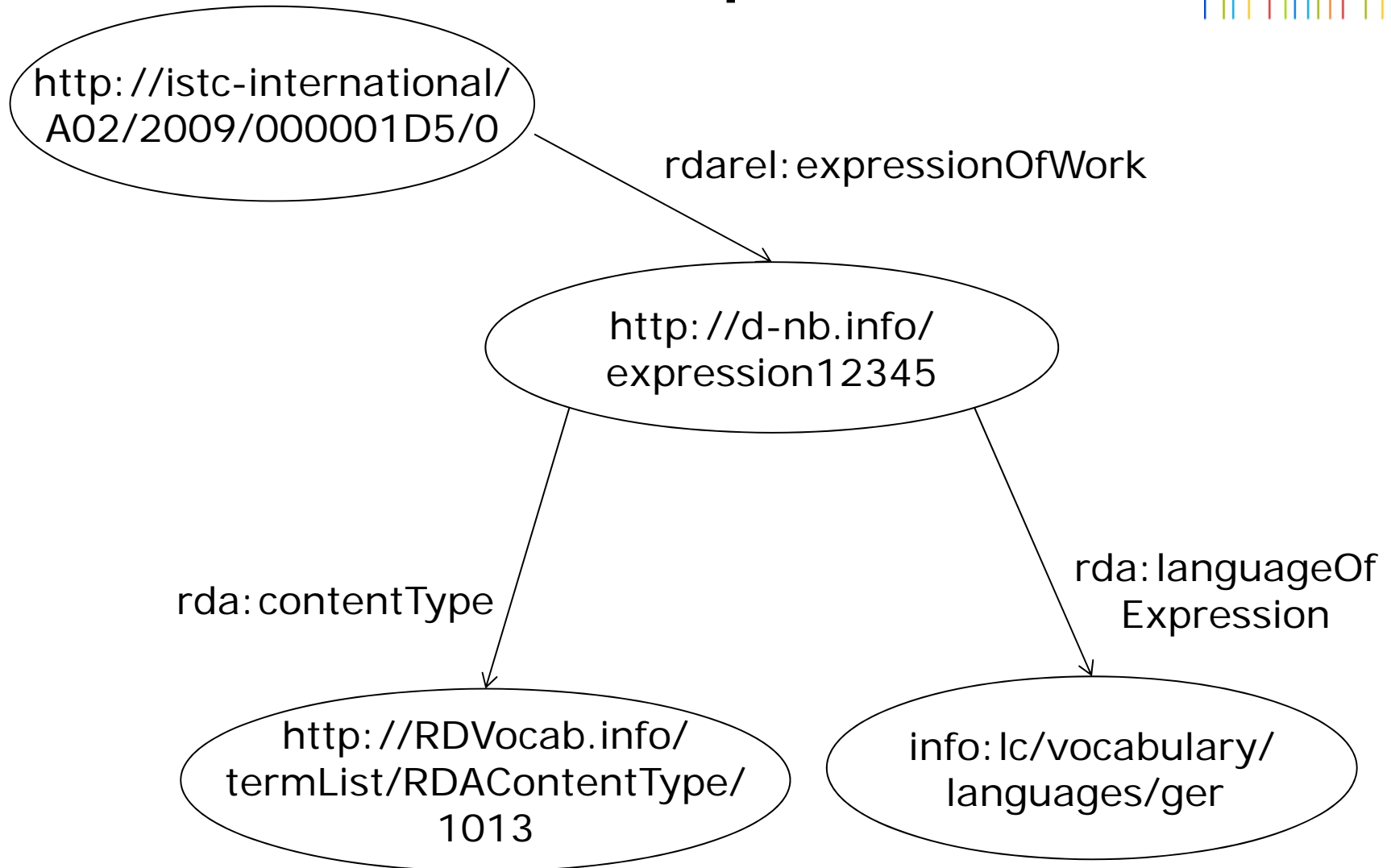

# Linked-RDA-Data-Beispiel

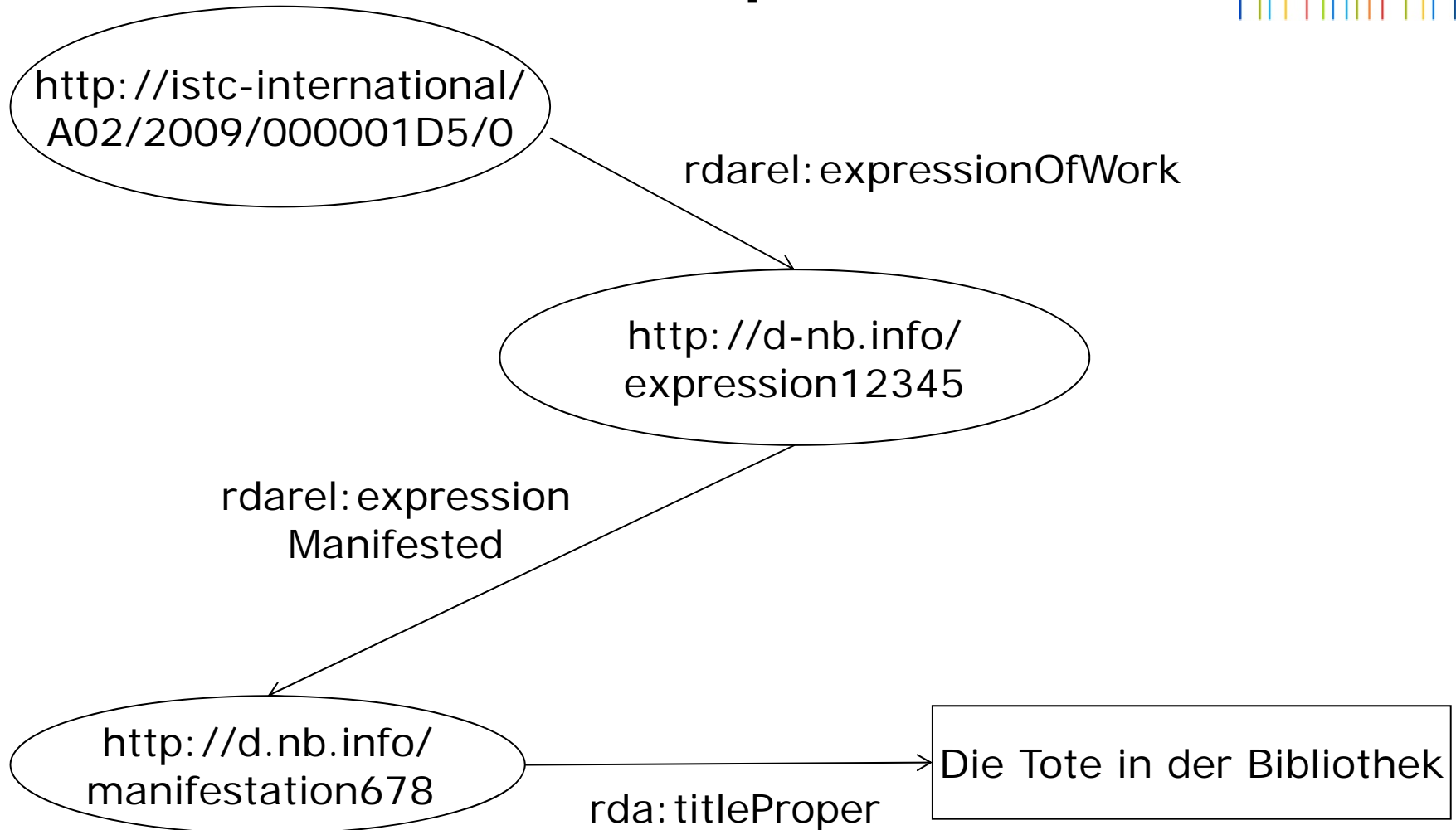

# Linked Data Service der DNB



- Umsetzung von
  - individualisierten Personen (PND)
  - Körperschaften (GKD)
  - Sachschlagwörtern (SWD)
  - DDC-Sachgruppen und DDC deutsch
  - CrissCross-Relationen



# Verlinkungen und Zahlen

- Normdatensätze
  - Individualisierte Personen (1.797.911)
  - Körperschaften (1.320.711)
  - Sachschlagwörter (187.743)
- Interne Verlinkungen
  - Personen -> Personen
  - Personen -> Körperschaften
  - Personen -> Sachschlagwörter (1.059.570)
  - Körperschaften -> Körperschaften
  - Körperschaften -> Personen
  - Körperschaften -> Sachschlagwörter
  - Sachschlagwörter -> Sachschlagwörter
- Externe Verlinkungen
  - Wikipedia (123.569)
  - DBpedia (40.136)
  - VIAF (1.786.975)
  - LCSH (37.547)
  - RAMEAU (28.249)

# Beschreibung Personen - RDA

attributes for the person		
	Address Of The Person	Name Of The Person
	Affiliation	✓ • Preferred Name For The Person
✓	Biographical Information	✓ • Variant Name For The Person
	Cataloguers Note	Note
✓	Country Associated With The Person	Other Designation Associated With The Person
	Date Associated With The Person	✓ Place Of Birth
✓	• Date Of Birth	✓ Place Of Death
✓	• Date Of Death	✓ Place Of Residence
✓	• Period Of Activity Of The Person	✓ Profession or Occupation
✓	Field Of Activity Of The Person	Source Consulted
	Fuller Form Of Name	Status Of Identification
✓	Gender	✓ Title Of The Person
✓	Identifier For The Person	Undifferentiated Name Indicator
✓	Language Of The Person	

# Beschreibung Personen - RDA

relationships for the person		
✓	Related Corporate Body (Person)	
	• Employee	
	• Group member	
	• Incumbent	
	• Sponsor	
	Related Family (Person)	
	• Family member	
	• Progenitor	
✓	Related Person (Person)	
	• Alternate identity	
	• Real identity	

# Beschreibung Personen - DNB



## Person

[gnd: preferredNameForThePerson](#)  
[gnd: variantNameForThePerson](#)  
[rdaGr2: titleOfThePerson](#)  
[gnd: academicTitleOfThePerson](#)  
[gnd: studyPathsOfThePerson](#)  
[rdaGr2: identifierForThePerson](#)  
[gnd: invalidIdentifierForThePerson](#)  
[rdaGr2: gender](#)  
[rdaGr2: dateOfBirth](#)  
[rdaGr2: dateOfDeath](#)  
[rdaGr2: placeOfBirth](#)  
[rdaGr2: placeOfDeath](#)  
[rdaGr2: placeOfResidence](#)  
[gnd: countryCodeForThePerson](#)  
[rdaGr2: languageOfThePerson](#)  
[rdaGr2: periodOfActivityOfThePerson](#)  
[rdaGr2: biographicalInformation](#)  
[rdaGr2: professionOrOccupation](#)  
[gnd: functionOfThePerson](#)  
[gnd: publicationOfThePerson](#)  
[foaf: homepage](#)  
[foaf: page](#)  
[rdaRelGr2: relatedPersonPerson](#)  
[relationship: spouseOf](#)  
[relationship: parentOf](#)  
[relationship: siblingOf](#)  
[relationship: childOf](#)  
[relationship: grandparentOf](#)  
[relationship: grandchildOf](#)  
[rdaRelGr2: relatedCorporateBodyPerson](#)  
[owl: sameAs](#)

# Abbildung von Namensbestandteilen

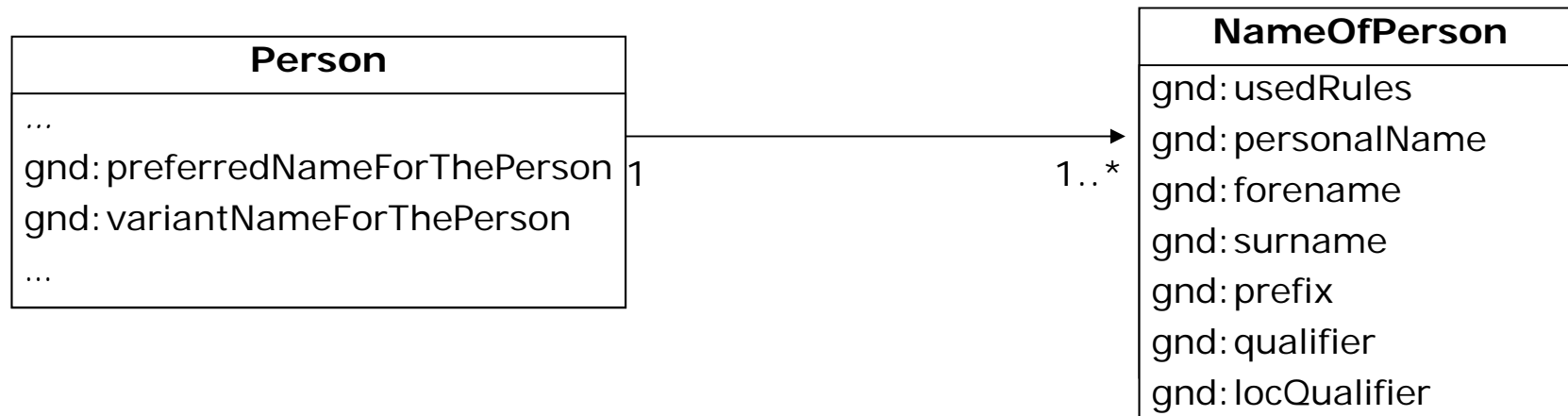

# Beschreibung Körperschaften - RDA

attributes for the corporate body		
Address of the Corporate Body	✓	Name of the Corporate Body
Associated Institution	✓	<ul style="list-style-type: none"> <li>Preferred Name for the Corporate Body</li> </ul>
Cataloguer's Note	✓	<ul style="list-style-type: none"> <li>Variant Name for the Corporate Body</li> </ul>
Corporate History		Note
Date Associated with the Corporate Body		Number of a Conference, Etc.
<ul style="list-style-type: none"> <li>Date of Conference, Etc.</li> </ul>		Other Designation Associated with the Corporate Body
<ul style="list-style-type: none"> <li>✓ Date of Establishment</li> </ul>	✓	Place Associated with the Corporate Body
<ul style="list-style-type: none"> <li>✓ Date of Termination</li> </ul>		<ul style="list-style-type: none"> <li>Location of Conference, Etc.</li> </ul>
Field of Activity of the Corporate Body		<ul style="list-style-type: none"> <li>Location of Headquarters</li> </ul>
✓ Identifier for the Corporate Body		Source Consulted
✓ Language of the Corporate Body		Status of Identification
		Undifferentiated Name Indicator

# Beschreibung Körperschaften - RDA

relationships for the corporate body		
✓	Related Corporate Body (Corporate Body)	
✓	• Hierarchical subordinate	
✓	• Hierarchical superior	
	• Mergee	
✓	• Predecessor	
	• Product of a merger	
	• Product of a split	
✓	• Successor	
	Related Family (Corporate Body)	
	• Founded organization	
	• Sponsored organization	
✓	Related Person (Corporate Body)	
	• Employer	

# Beschreibung Körperschaften - DNB

## Corporate Body

[gnd:preferredNameForTheCorporateBody](#)  
[gnd:preferredNameAcronymForTheCorporateBody](#)  
[rdaGr2:nameOfTheCorporateBody](#)  
[gnd:variantNameForTheCorporateBody](#)  
[gnd:variantNameAcronymForTheCorporateBody](#)  
[rdaGr2:identifierForTheCorporateBody](#)  
[gnd:invalidIdentifierForTheCorporateBody](#)  
[rdaGr2:dateOfEstablishment](#)  
[rdaGr2:dateOfTermination](#)  
[gnd:countyCodeForTheCorporateBody](#)  
[rdaGr2:languageOfTheCorporateBody](#)  
[gnd:functionOfTheCorporateBody](#)  
[foaf:homepage](#)  
[rdaRelGr2:hierarchicalSubordinate](#)  
[rdaRelGr2:hierarchicalSuperior](#)  
[rdaRelGr2:predecessor](#)  
[rdaRelGr2:successor](#)  
[gnd:predecessorWithoutSuccessor](#)  
[gnd:successorWithoutPredecessor](#)  
[rdfs:seeAlso](#)



# Grenzen derzeitiger RDA-Ontologien

- Aggregation von Informationen
  - MARC 21 Beispiel:
    - 370 ## \$eBerlin \$s1928 \$t1933
    - 370 ## \$eDresden \$s1933 \$t1939

- RDF-Beispiel:

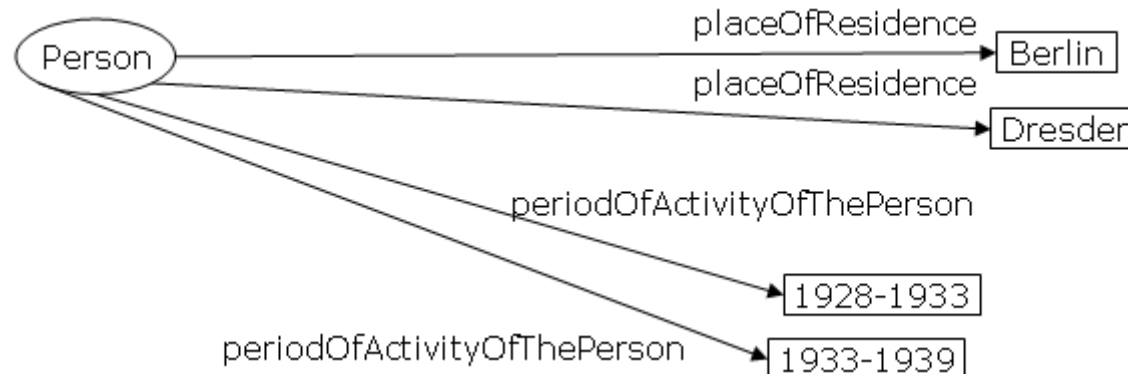

# Grenzen derzeitiger RDA-Ontologien

- Aggregation von Informationen
  - MARC 21 Beispiel:
    - 370 ## \$eBerlin \$s1928 \$t1933
    - 370 ## \$eDresden \$s1933 \$t1939
  - RDF-Beispiel - Lösungsansatz:

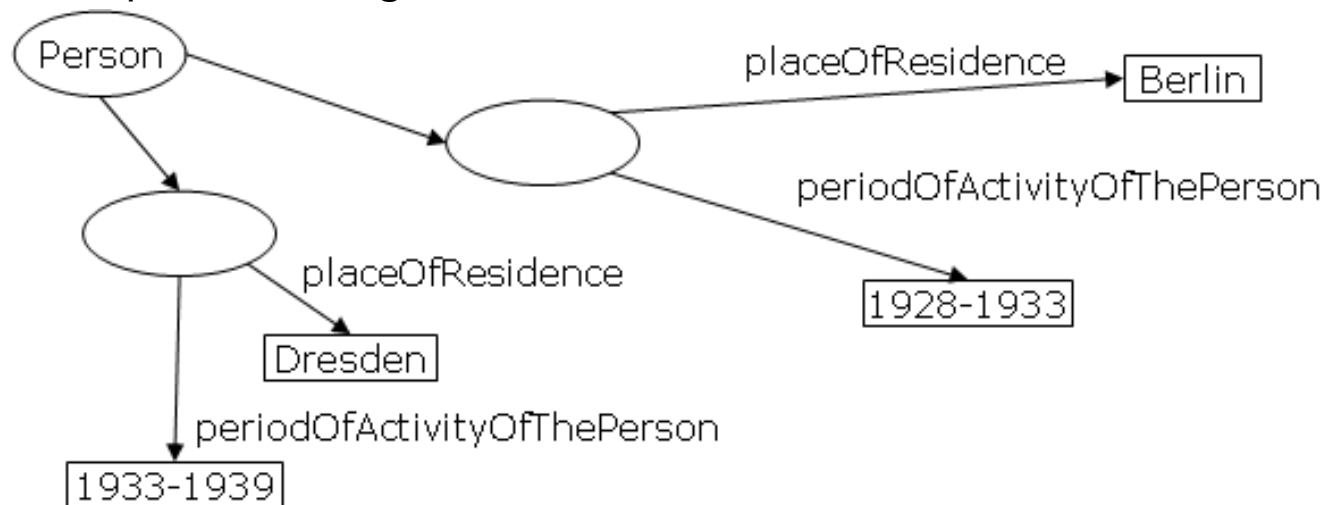

# Grenzen derzeitiger RDA-Onto- logien

## Person

- Meta-Metadaten
  - Umsetzung laut RDA-Regelwerk

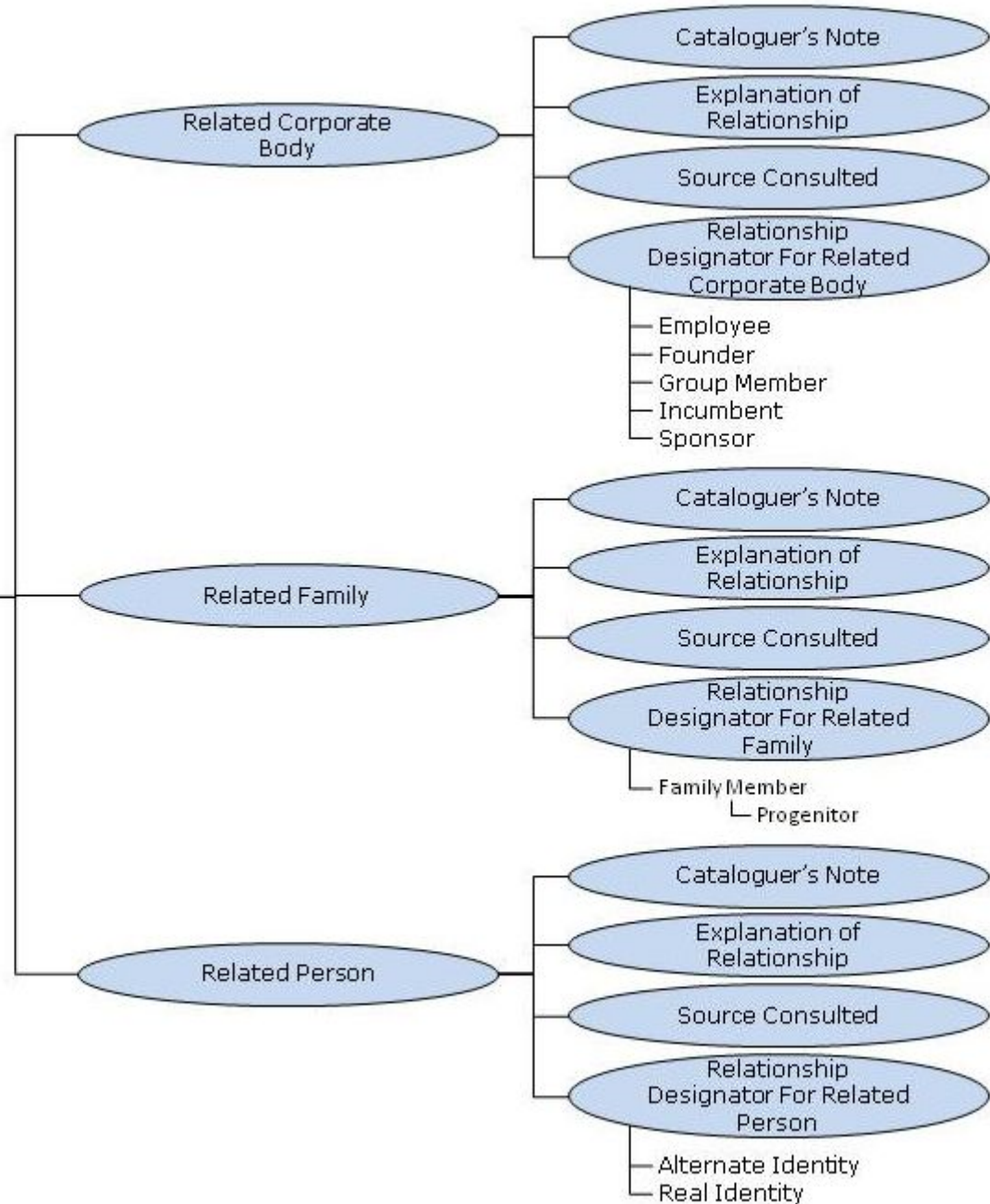

# Grenzen derzeitiger RDA-Ontologien

Meta-Metadaten

derzeitige Umsetzung im RDA Element Set:

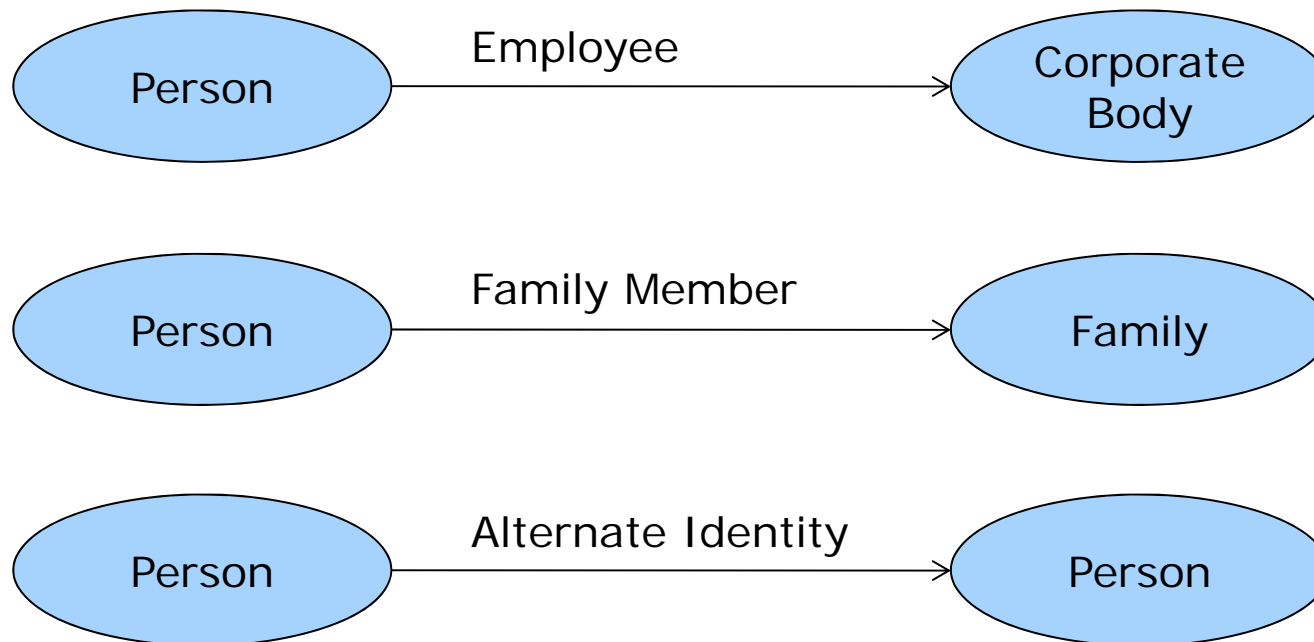

# Grenzen derzeitiger RDA-Ontologien

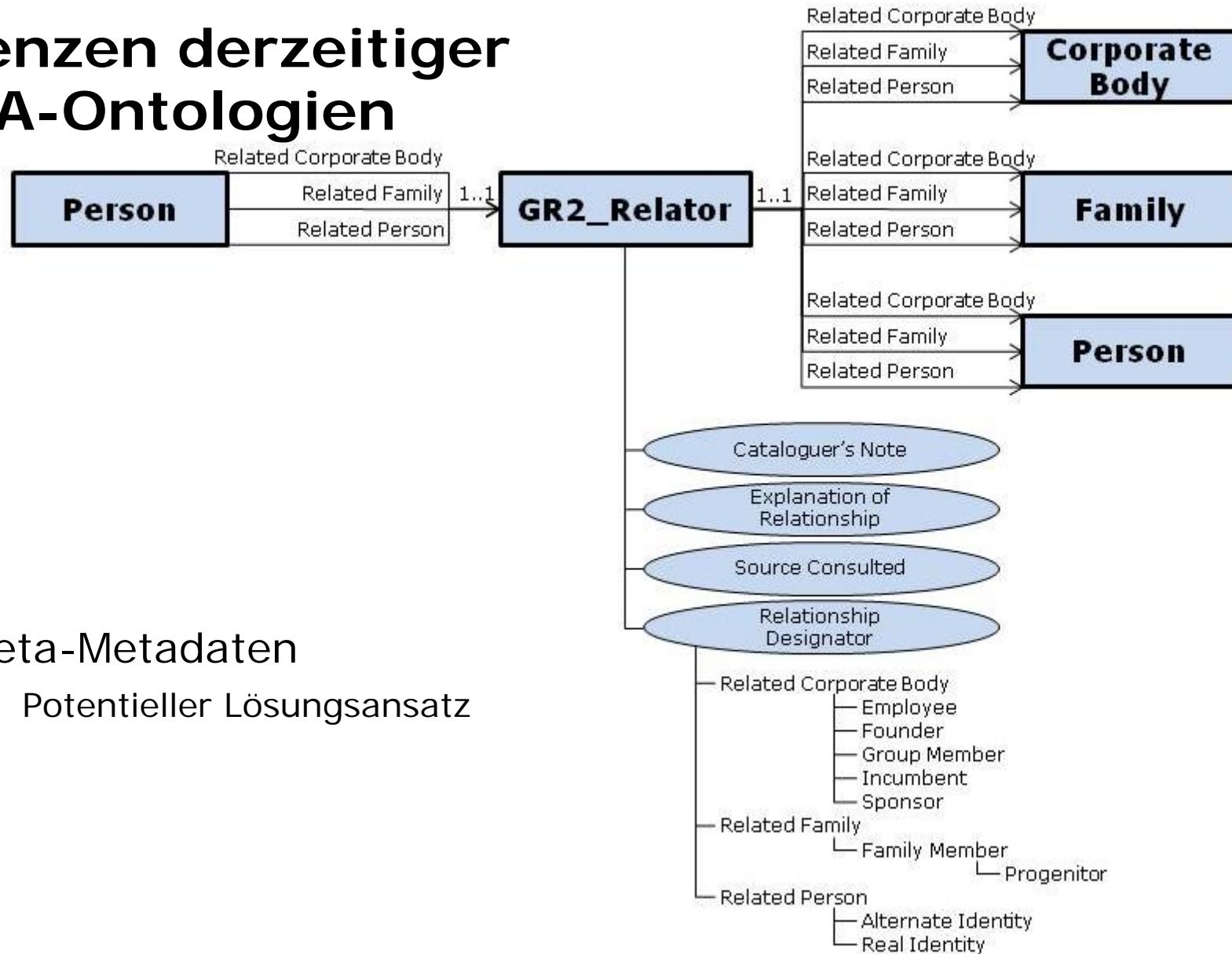

- Meta-Metadaten
  - Potentieller Lösungsansatz

# Beschreibung Sachschlagwörter – DNB

Subject Headings
skos:prefLabel
skos:altLabel
dcterms:identifier
gnd:invalidIdentifierForTheSubject
skos:definition
skos:scopeNote
gnd:countryCodeForTheSubject
dcterms:language
rdfs:label
gnd:useConceptsInsteadSWD
skos:broader
skos:related
skos:closeMatch
gnd:hasCoordinatedConceptOf

# SWD-DDC-Verknüpfung

```
<rdf:RDF xmlns:gnd="http://d-nb.info/gnd/" xmlns:skos="http://www.w3.org/2004/02/skos/core#"
  xmlns:dnb="http://d-nb.info/" xmlns:rdaFrbr="http://RDVocab.info/uri/schema/FRBREntitiesRDA"
  xmlns:rdf="http://www.w3.org/1999/02/22-rdf-syntax-ns#" xmlns:dcterms="http://purl.org/dc/terms/" >
```

```
<rdf:Description rdf:about="http://d-nb.info/gnd/4006111-5">
  <rdf:type rdf:resource="http://www.w3.org/2004/02/skos/core#Concept"/>
```

```
<skos:prefLabel xml:lang="de">Beton</skos:prefLabel>
```

```
<dcterms:identifier>(DE-588)040061116</dcterms:identifier>
```

```
<dcterms:identifier>(DE-588c)4006111-5</dcterms:identifier>
```

```
<skos:broader rdf:resource="http://d-nb.info/gnd/4004945-0"/>
```

```
<skos:closeMatch rdf:resource="http://id.loc.gov/authorities/sh85030647#concept"/>
```

```
<skos:closeMatch rdf:resource="http://stitch.cs.vu.nl/vocabularies/rameau/ark:/12148/cb11931040z"/>
```

```
➔ <dnb:hasCoordinatedConcept-of rdf:nodeID="4006111-5#A0"/>
  </rdf:Description>
```

```
<rdf:Description rdf:nodeID="4006111-5#A0">
```

```
➔ <dnb:det2 rdf:resource="http://d-nb.info/ddc/class/620.136"/>
  <dnb:coordination-of rdf:resource="http://d-nb.info/gnd/4006111-5"/>
  <dnb:coordination-of rdf:resource="http://d-nb.info/ddc-sg/620"/>
  <rdf:type rdf:resource="http://d-nb.info/CoordinatedConcept"/>
```

```
</rdf:Description>
```

```
</rdf:RDF>
```

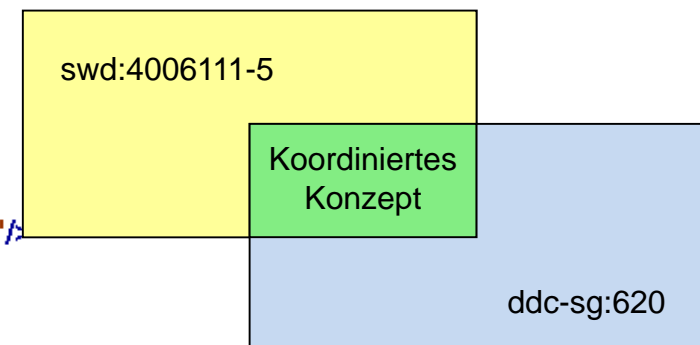

# Beschreibung Nicht-Deskriptor

```
<rdf:RDF xmlns:skos="http://www.w3.org/2004/02/skos/core#"
  xmlns:gnd="http://d-nb.info/gnd/" xmlns:rdf="http://www.w3.org/1999/02/22-rdf-syntax-ns#"
  xmlns:dcterms="http://purl.org/dc/terms/" xmlns:rdfs="http://www.w3.org/2000/01/rdf-schema#" >
```

```
<rdf:Description rdf:about="http://d-nb.info/gnd/7507258-0">
  <rdf:type rdf:resource="http://d-nb.info/gnd/NonDescriptor"/>
```

```
<rdfs:label xml:lang="de">Betonkorrosion</rdfs:label>
```

```
<dcterms:identfier>(DE-588)130741531</dcterms:identfier>
```

```
<dcterms:identfier>(DE-588c)7507258-0</dcterms:identfier>
```

```
<gnd:invalidIdentifierForTheSubject>(DE-588c)4388788-0</gnd:invalidIdentifierForTheSubject>
```

```
➔ <gnd:useConceptsInsteadSWD rdf:nodeID="7507258-0#A0"/>
```

```
<gnd:useInsteadNoteSWD xml:lang="de">Verwende alle gnd:useInsteadSWD-Terme, um diesen
  Nicht-Deskriptor abzubilden.</gnd:useInsteadNoteSWD>
```

```
<gnd:useInsteadNoteSWD xml:lang="en">Use all gnd:useInsteadSWD-Terms to represent this
  non-descriptor.</gnd:useInsteadNoteSWD>
```

```
</rdf:Description>
```

```
➔ <rdf:Description rdf:nodeID="7507258-0#A0">
```

```
<gnd:useInsteadSWD rdf:resource="http://d-nb.info/gnd/4006111-5"/>
```

```
<gnd:useInsteadSWD rdf:resource="http://d-nb.info/gnd/4032518-0"/>
```

```
</rdf:Description>
```

```
</rdf:RDF>
```



# Beschreibung Nicht-Deskriptor

- Problem der Katalogisierungspraxis:
  - fehlende Semantik von Nicht-Deskriptoren

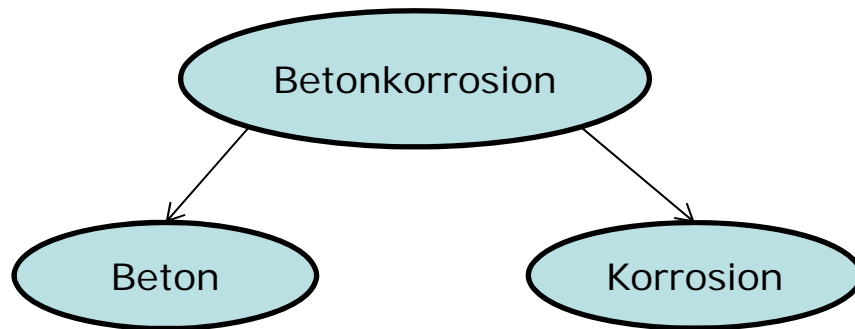

besser wäre

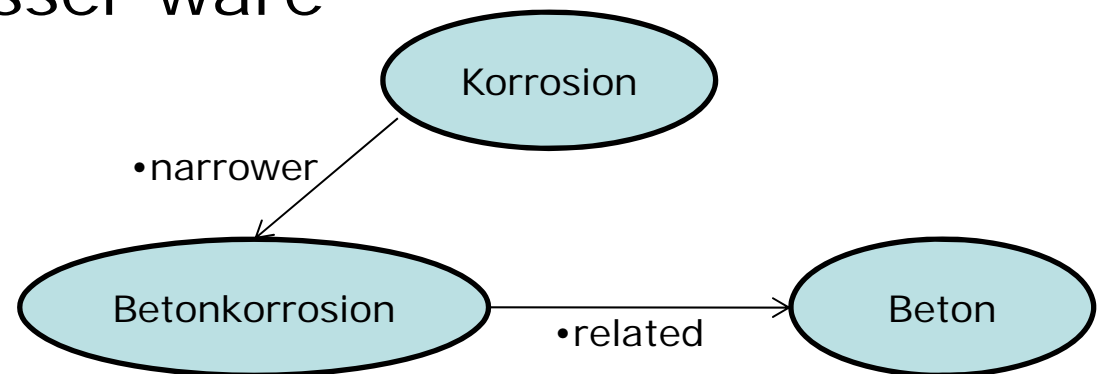

# Die Architektur des DNB-LD-Service



- hybrider Architekturansatz
  - Internsystem und Triple-Store
- bei Anfrage Konvertierung von RDF-Daten on-the-fly
  - Überführung der Informationen aus Internformat
  - Anreicherung von Links zu externen Datenrepräsentationen
- Datenbereitstellung
  - im Portal
  - Gesamtdatenabzug zum Download

# Geplante Weiterentwicklung

- Ende 2010
  - Bereitstellung OAI- und SRU-Schnittstelle für RDF
  - URI-Konzept
- 2011 +
  - Verlinkung SWD → STW
  - Aufnahme von nicht-individualisierten Personen und Familien
  - Verfeinerung der Modellierung für Normdaten
  - Bereitstellung von Titeldaten
  - Evaluierung von Triple-Stores zur permanenten Linked-Data-Datenhaltung

# Bibliografische Daten in RDA Weg zur FRBRisierung

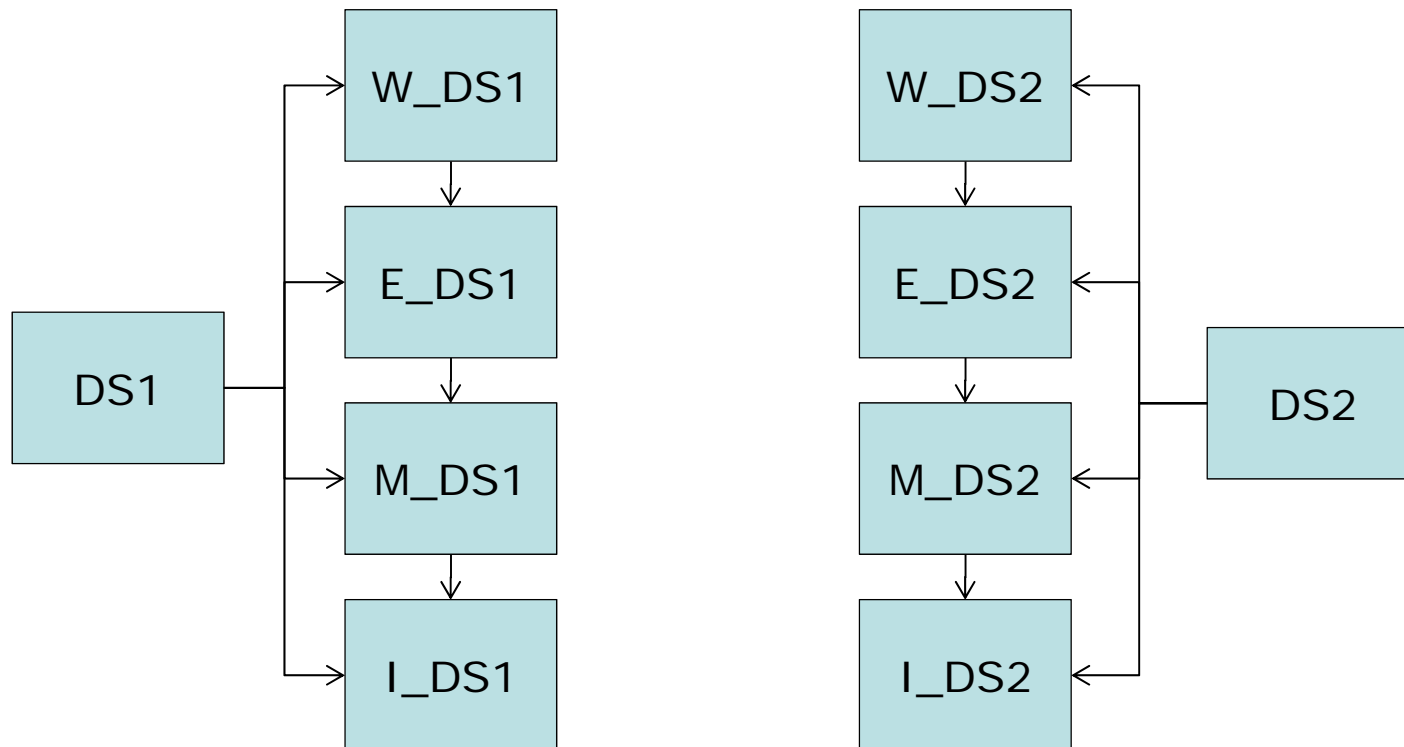

# Bibliografische Daten in RDA

## Weg zur FRBRisierung

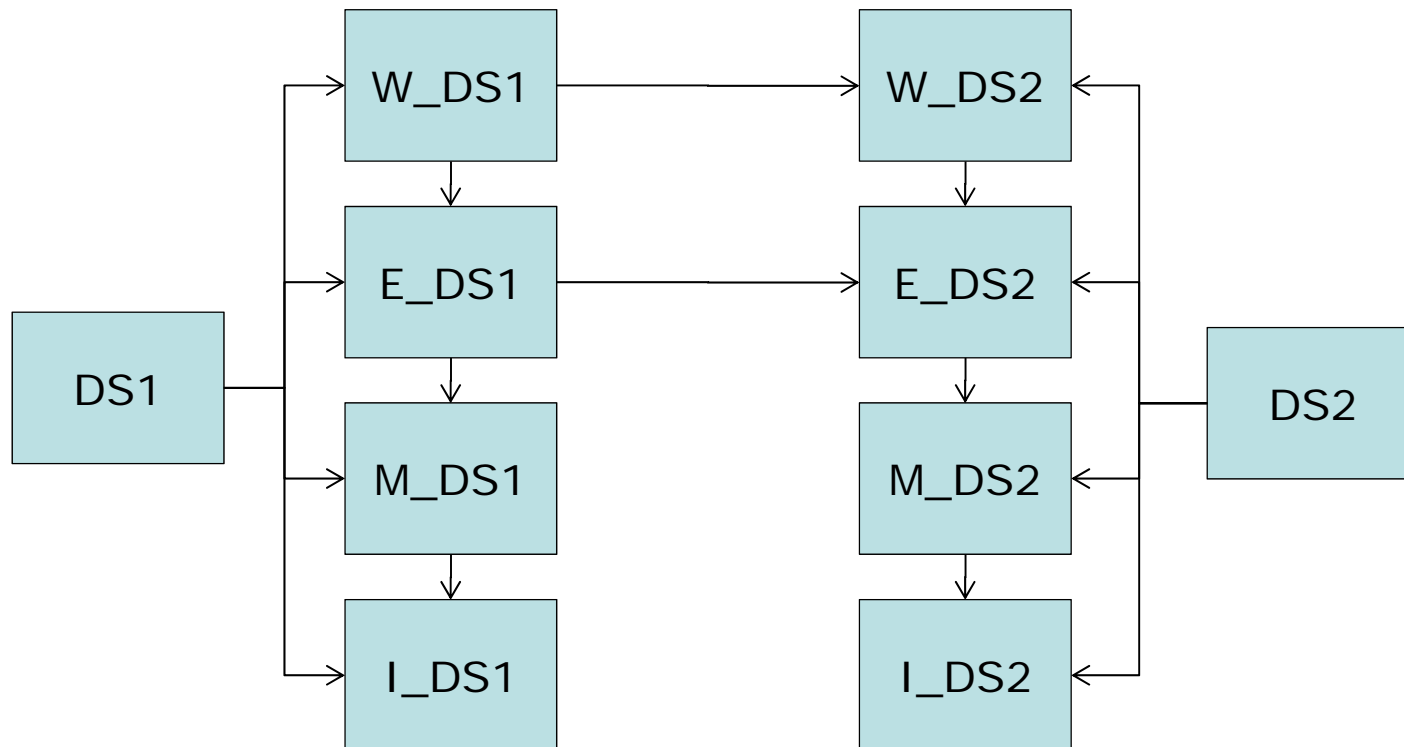

# Bibliografische Daten in RDA

## Weg zur FRBRisierung

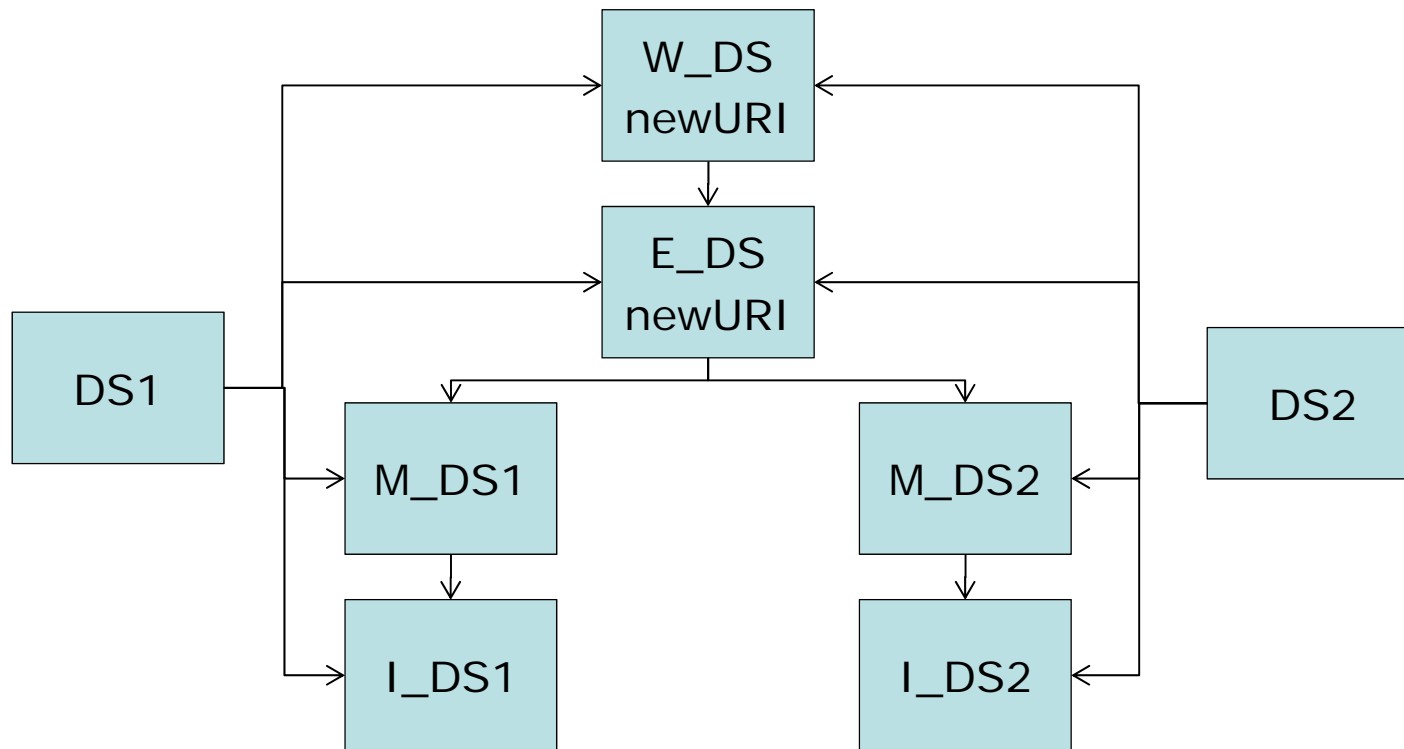

# Fazit und Ausblick

- Normdaten als Rückgrat von Linked Library Data
  - multiple Repräsentationen notwendig?
- Infrastruktur der Zukunft?
  - dezentrale Datenhaltung und –bereitstellung
  - zentrale Ankerpunkte als Aggregatoren
- Werkzeuge zur RDA-konformen Katalogisierung
- Präsentation für den Endnutzer

# Vielen Dank!

discussion is welcome...

Linked Data Service der Deutschen Nationalbibliothek  
[http://www.d-nb.de/eng/hilfe/service/linked\\_data\\_service.htm](http://www.d-nb.de/eng/hilfe/service/linked_data_service.htm)